



Aquai ux
雅佳乐

PROFESSIONAL

PRECIOUS
EXCELLENT QUALITY

备注：本公司对产品有最终解释权，一切以实物为准！
Aquaiux 电话：021-61849378 网址：www.Aquaiux.cn

DW-1001G

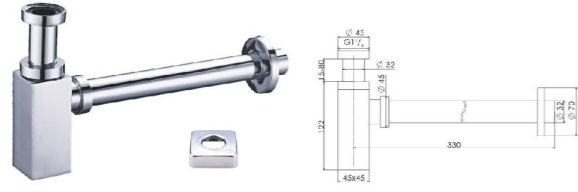

产品应用

- 台盆式落水安装
- SQUARE SIPHON(1" 1/4)

产品特性

- 材料: 铜 (BRASS)

DW-1002G

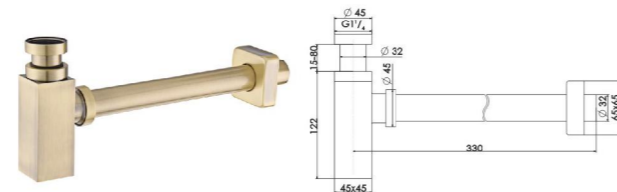

产品应用

- 台盆式落水安装
- SQUARE SIPHON(1" 1/4)

产品特性

- 材料: 铜 (BRASS)

DW-1005G



产品应用

- 台盆式落水安装
- SQUARE SIPHON(1" 1/4)

产品特性

- 材料: 铜 (BRASS)

DW-1006G



产品应用

- 台盆式落水安装(国标)

产品特性

- 材料: 铜 (BRASS) 不锈钢 (SS304)

DW-1003G

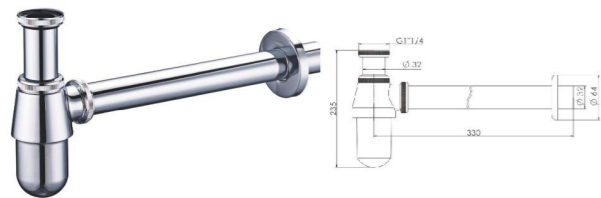

产品应用

- 台盆式落水安装
- SQUARE SIPHON(1" 1/4)

产品特性

- 材料: 铜 (BRASS)

DW-1004G

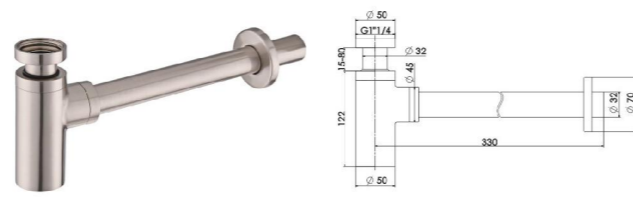

产品应用

- 台盆式落水安装
- SQUARE SIPHON(1" 1/4)

产品特性

- 材料: 铜 (BRASS)

DW-1007G

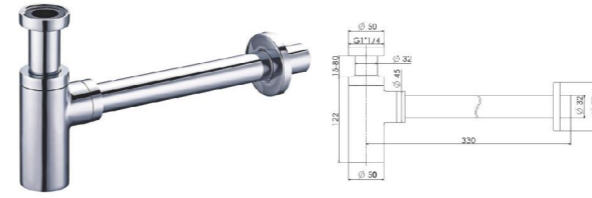

产品应用

- 台盆式落水安装
- SQUARE SIPHON(1" 1/4)

产品特性

- 材料: 铜 (BRASS)

DW-1008G

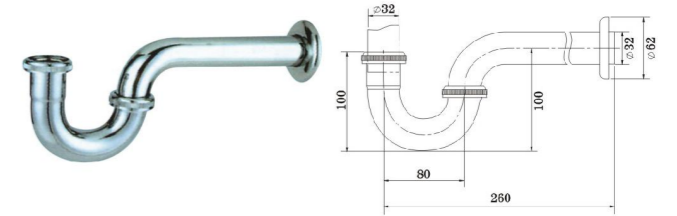

产品应用

- 台盆式落水安装
- P-TRAP(1" 1/4)

产品特性

- 材料: 铜 (BRASS) 不锈钢 (SS304)

备注：本公司对产品有最终解释权，一切以实物为准！
 Aquaiux 电话：021-61849378 网址：www.Aquaiux.cn

DW-1009G

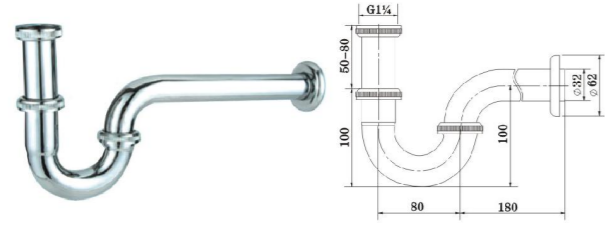

产品应用

- 面板式的落水安装
- P-TRAP(1" 1/4)

产品特性

- 材料: 铜 (BRASS) 不锈钢 (SS304)

DW-1010G

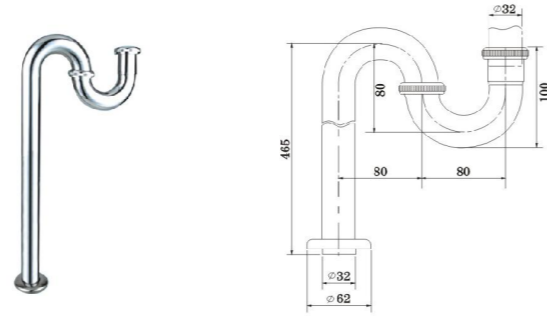

产品应用

- 台盆式落水安装
- S-TRAP(1" 1/4)

产品特性

- 材料: 铜 (BRASS) 不锈钢 (SS304)

DW-1013G

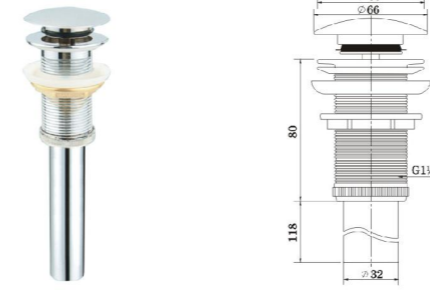

产品应用

- 面盆弹跳落水 (有溢水孔)
- WASTE FOR WASH BASIN(1" 1/4 CLIC-CLAC)

产品特性

- 材料: 铜 (BRASS) 不锈钢

DW-1014G

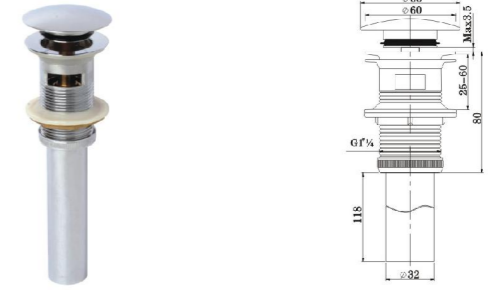

产品应用

- 面盆弹跳落水 (无溢水孔)
- WASTE FOR WASH BASIN(1" 1/4 CLIC-CLAC)

产品特性

- 材料: 铜 (BRASS) 不锈钢

DW-1011G

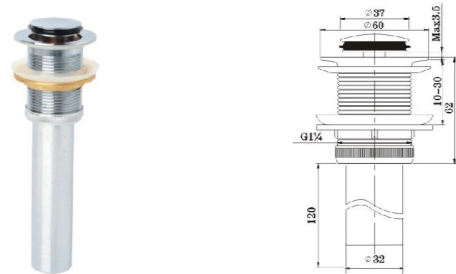

产品应用

- 面盆弹跳落水 (有溢水孔)
- WASTE FOR WASH BASIN(1" 1/4 CLIC-CLAC)

产品特性

- 材料: 铜 (BRASS) 不锈钢

DW-1012G

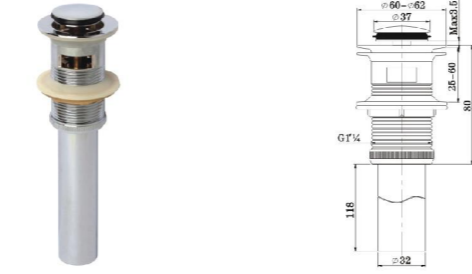

产品应用

- 面盆弹跳落水 (无溢水孔)
- WASTE FOR WASH BASIN(1" 1/4 CLIC-CLAC)

产品特性

- 材料: 铜 (BRASS) 不锈钢

DW-1015G

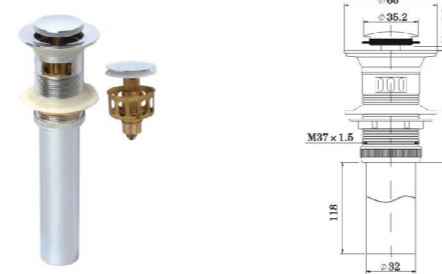

产品应用

- 面盆弹跳落水 (有溢水孔)
- (BRASS WASTE FOR WASH BASIN 1" WITH FILTER-BASKET AND OVERFLOW CLIC-CLAC)

产品特性

- 材料: 铜 (BRASS) 不锈钢

DW-1016G

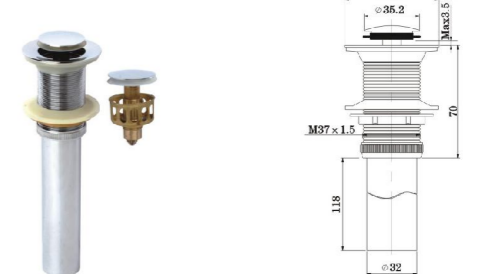

产品应用

- 面盆弹跳落水 (有溢水孔)
- (BRASS WASTE FOR WASH BASIN 1" WITH FILTER-BASKET CLIC-CLAC)

产品特性

- 材料: 铜 (BRASS) 不锈钢

备注：本公司对产品有最终解释权，一切以实物为准！
 Aquaiux 电话：021-61849378 网址：www.Aquaiux.cn

DW-1017G

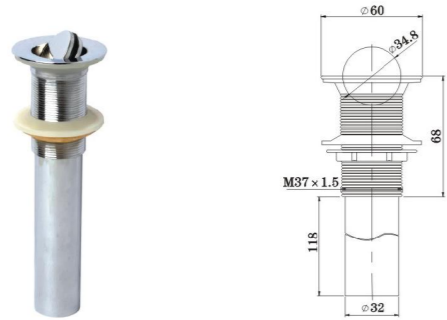

产品应用

- 面盆翻版落水(无溢水孔)
- ROTATING TOP(WASTE FOR WASH BASIN 1”

产品特性

- 材料:铜(BRASS) 不锈钢

DW-1018G

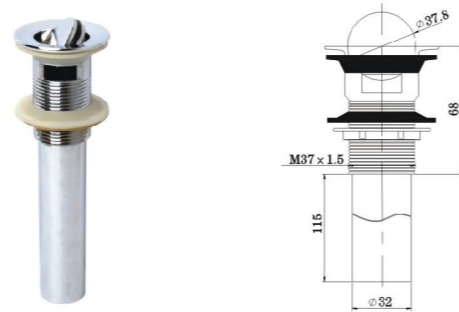

产品应用

- 面盆翻版落水(有溢水孔)
- ROTATING TOP (WASTE FOR WASH BASIN 1” WITH OVERFLOW

产品特性

- 材料:铜(BRASS) 不锈钢

DW-1021G

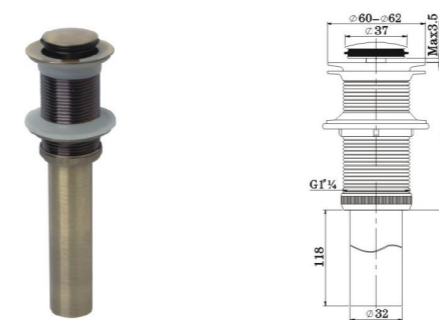

产品应用

- 面盆弹跳落水(有溢水孔)
- BRASS WASTE FOR WASH BASIN 1” 1/4 WITH OVERFLOW CLIC-CLAC ANTIQUE COPPER

产品特性

- 材料:铜(BRASS) 不锈钢

DW-1022G

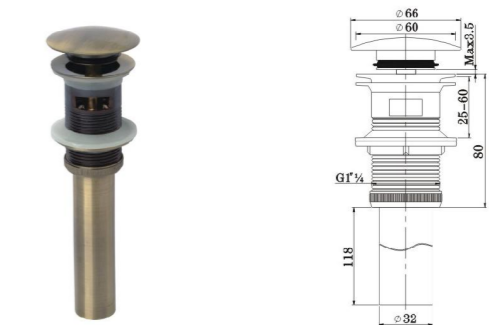

产品应用

- 面盆弹跳落水(有溢水孔)
- BRASS WASTE FOR WASH BASIN 1” 1/4 WITH OVERFLOW CLIC-CLAC ANTIQUE COPPER

产品特性

- 材料:铜(BRASS) 不锈钢

DW-1019G

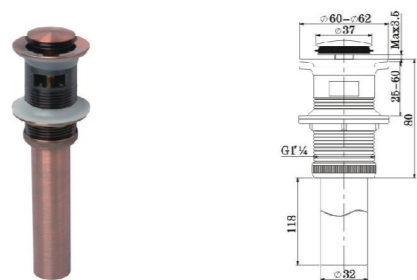

产品应用

- 面盆弹跳落水(有溢水孔)
- BRASS WASTE FOR WASH BASIN 1” 1/4 WITH OVERFLOW CLIC-CLAC ANTIQUE COPPER

产品特性

- 材料:铜(BRASS) 不锈钢

DW-1012G

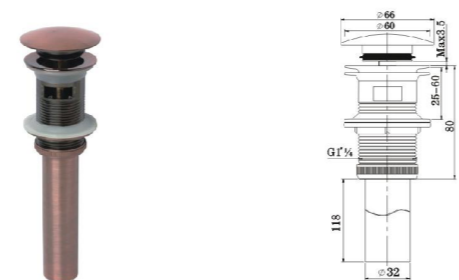

产品应用

- 面盆弹跳落水(有溢水孔)
- BRASS WASTE FOR WASH BASIN 1” 1/4 WITH OVERFLOW CLIC-CLAC ANTIQUE COPPER

产品特性

- 材料:铜(BRASS) 不锈钢

DW-1023G

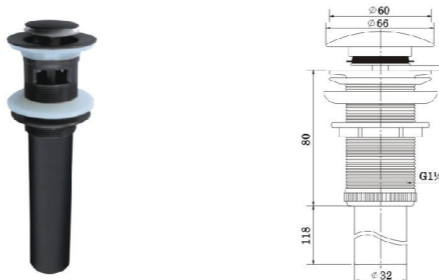

产品应用

- 面盆弹跳落水(有溢水孔)
- BRASS WASTE FOR WASH BASIN 1” 1/4 WITH OVERFLOW CLIC-CLAC ANTIQUE COPPER

产品特性

- 材料:铜(BRASS) 不锈钢

DW-1024G

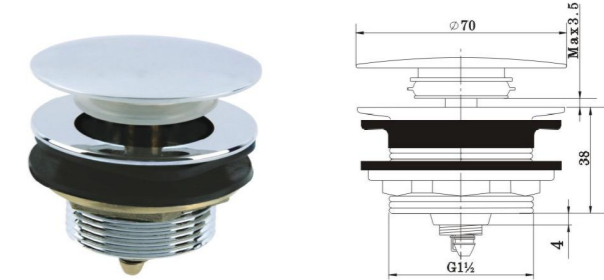

产品应用

- 浴缸弹跳落水(无溢水孔)
- BRASS WASTE FOR WASH BASIN 1” 1/4 WITH OVERFLOW CLIC-CLAC ANTIQUE COPPER

产品特性

- 材料:铜(BRASS) 不锈钢

备注：本公司对产品有最终解释权，一切以实物为准！
 Aquaiux 电话：021-61849378 网址：www.Aquaiux.cn

DW-1025G

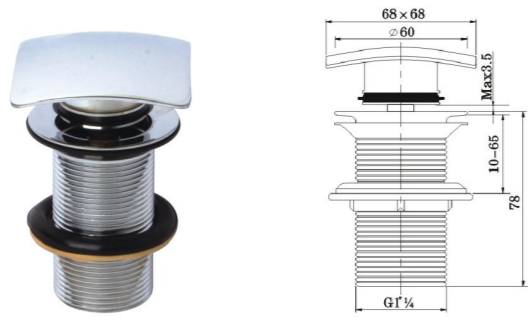

产品应用

• 浴缸弹跳落水 (无溢水孔)
-BRASS WASTE FOR BATHTUB 1" 1/2 CLIC-CLAC
ANTIQUÉ COPPER

产品特性

• 材料: 铜 (BRASS)

DW-1026G

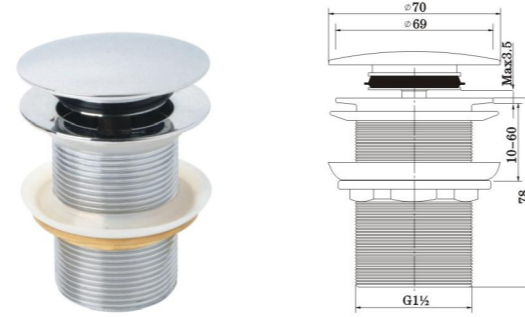

产品应用

• 浴缸弹跳落水 (无溢水孔)
-BRASS WASTE FOR BATHTUB 1" 1/2 CLIC-CLAC
ANTIQUÉ COPPER

产品特性

• 材料: 铜 (BRASS)

DW-1001J

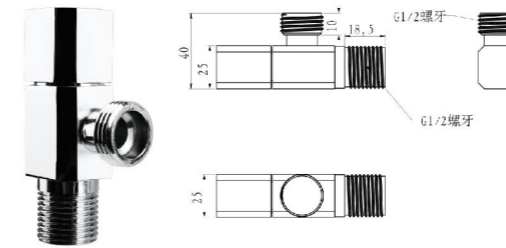

产品应用

• 面盆龙头, 菜盆龙头, 热水器, 马桶
• APPLICATIONS: BASIN, FAUCET, KITCHEN, KITCHEN, FAUCET, WATER HEATER, TOILET

产品特性

• 材料: 铜 (BRASS) • 尺寸: G1/2*1/2

DW-1002J

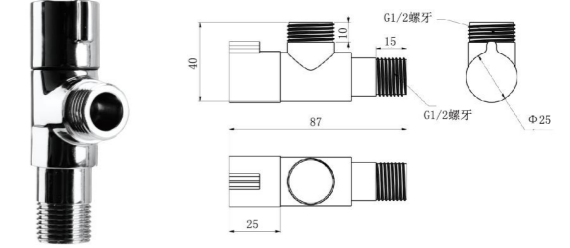

产品应用

• 面盆龙头, 菜盆龙头, 热水器, 马桶
• APPLICATIONS: BASIN, FAUCET, KITCHEN, KITCHEN, FAUCET, WATER HEATER, TOILET

产品特性

• 材料: 铜 (BRASS) • 尺寸: G1/2*1/2

DW-1019G



产品应用

• 用于进口欧标下水接管 (专配欧洲进口卫浴品牌)

产品特性

• 材料: 铜+钢 • 尺寸: 13CM/20CM

DW-1003J

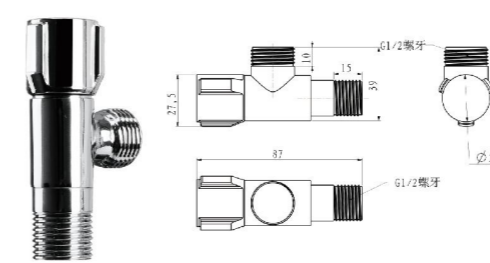

产品应用

• 面盆龙头, 菜盆龙头, 热水器, 马桶
• APPLICATIONS: BASIN, FAUCET, KITCHEN, KITCHEN, FAUCET, WATER HEATER, TOILET

产品特性

• 材料: 铜 (BRASS) • 尺寸: G1/2*1/2

DW-1004J

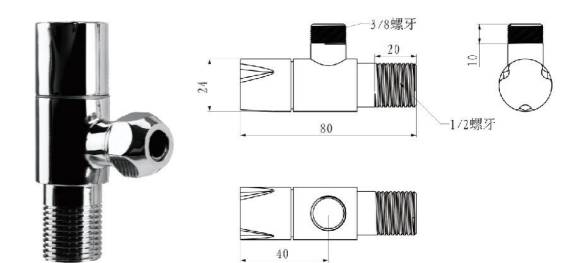

产品应用

• 面盆弹跳落水 (无溢水孔)
• BRASS WASTE FOR WASH BASIN 1" 1/4 WITH
OVERFLOW CLIC-CLAC ANTIQUÉ COPPER

产品特性

• 材料: 铜 (BRASS) 不锈钢

备注: 本公司对产品有最终解释权, 一切以实物为准!
Aquaiux 电话: 021-61849378 网址: www.Aquaiux.cn

2672

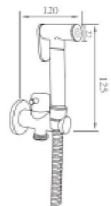

产品特性
·材料:黄铜

2674

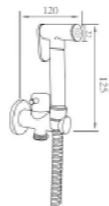

产品特性
·材料:黄铜

2769

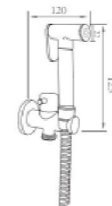

产品特性
·材料:黄铜

2770

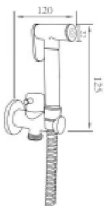

产品特性
·材料:黄铜

2543

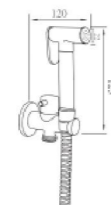

产品特性
·材料:黄铜

2756

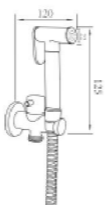

产品特性
·材料:黄铜

2771

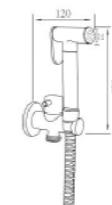

产品特性
·材料:黄铜

2773

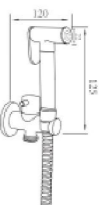

产品特性
·材料:黄铜

2766

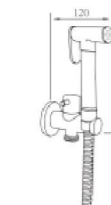

产品特性
·材料:黄铜

2767

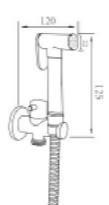

产品特性
·材料:黄铜

2774

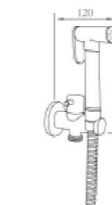

产品特性
·材料:黄铜

2775

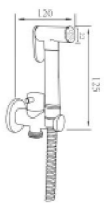

产品特性
·材料:黄铜

备注：本公司对产品有最终解释权，一切以实物为准！
Aquaiux 电话：021-61849378 网址：www.Aquaiux.cn

2777



产品特性
·材料:黄铜

2778



产品特性
·材料:黄铜

2569



产品特性
·材料:黄铜 表面处理:拉丝

2559

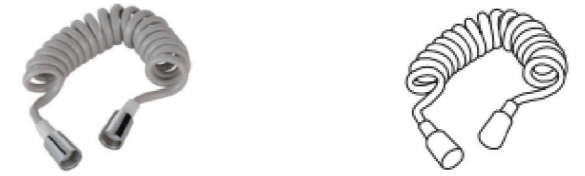

产品特性
·材料:pvc 表面处理:灰色

编织管、软管系列

2527



产品特性
·材料:黄铜 表面处理:拉丝

2528/2564/2565/2566



产品特性
·材料:不锈钢 表面处理:拉丝

5529



产品特性
·材料:pvc 表面处理:银灰色

2530



产品特性
·材料:304不锈钢 表面处理:镀铬

2567



产品特性
·材料:黄铜 表面处理:拉丝

2568



产品特性
·材料:黄铜 表面处理:拉丝

2588



产品特性
·材料:不锈钢 表面处理:金色

2594



产品特性
·材料:不锈钢 表面处理:黑色

2541

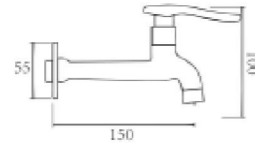

产品特性
·材料:黄铜

2542

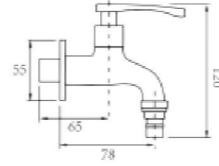

产品特性
·材料:黄铜

2757

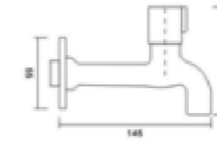

产品特性
·材料:黄铜

2758

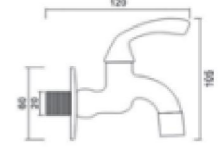

产品特性
·材料:黄铜

2561

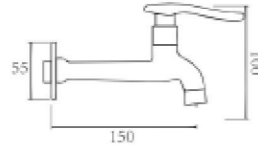

产品特性
·材料:黄铜

2562

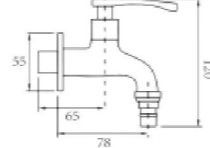

产品特性
·材料:黄铜

2760

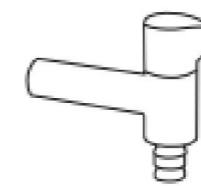

产品特性
·材料:黄铜

2761

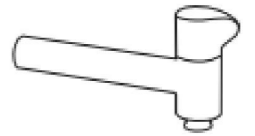

产品特性
·材料:黄铜

2574

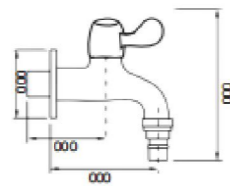

产品特性
·材料:黄铜

2575

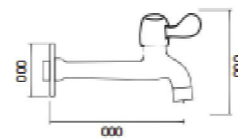

产品特性
·材料:黄铜

DW-1017H

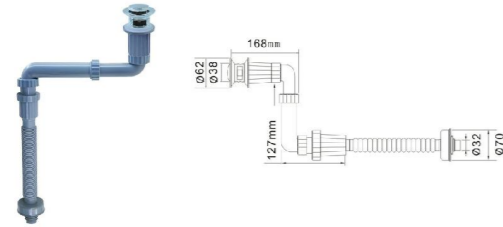

浴室柜、面盆下水器

- 金属材质:铜/不锈钢塑料材质:PP/ABS
- 开孔尺寸:去水开孔30
- 表面处理:镀铬拉丝青古铜/钛金/ORB
- 产品功能:自动溢水、止溢水、带伸缩、防臭、弹跳式去水

BATHROOMCABINETANDBASINDRAIN

- Plasticmaterial:PP/ABS
- Metalmaterial : Copper/Stainlesssteel
- Holesize:Drainageholesize35;
- Surfacetreatment:CHROMEPLATE/BRUSH/BRONZE/TITANIUM/ORB
- Productfunctions:overflowautomaticall/Telescopic/deodorant/Bouncetype

DW-1018H

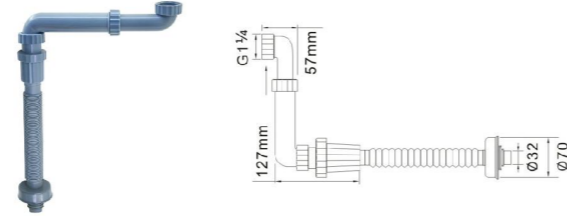

浴室柜、面盆下水管

- 塑料材质:PP/ABS
- 产品功能:带伸缩、防臭去水管

DRAINPIPEOFBATHROOMCABINETANDBASIN

- Plasticmaterial:PP/ABS
- Productfunctions:Extensible/deodorant

DW-2021H



G1活接伸缩排水管

- 塑料材质:PP/PE
- 规格32*800mm/1000mm/1200mm
- 颜色:黑、白、灰

DESCRIPTION:G1FLEXIBLEDRAINHOSE

- Size:Ø32*80mm/1000mm/1200mm
- Color:Black/White/Grey

DW-2022H



G1活接伸缩排水管

- 塑料材质:PP/PE
- 规格40*800mm/1000mm/1200mm
- 颜色:黑、白、灰

DESCRIPTION:G1FLEXIBLEDRAINHOSE

- Size:40*800mm/1000mm/1200mm
- Color:Black/White/Grey

DW-1019H

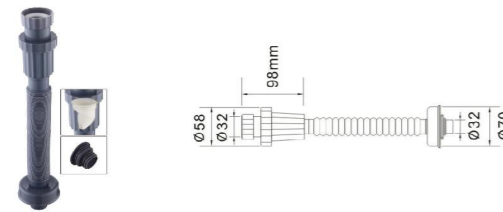

浴室柜、面盆下水管

- 塑料材质:PP/ABS
- 产品功能:防臭下水管

DRAINFORBATHROOMCABINETANDBASIN

- Plasticmaterial:PP/ABS
- Productfuntions:deodorant/Extensible

DW-1019H-1

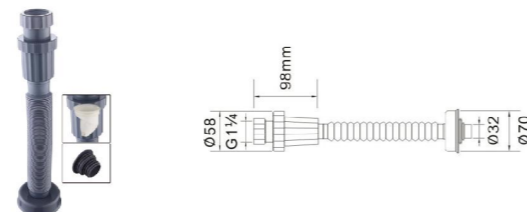

浴室柜、面盆下水管

- 塑料材质:PP/ABS
- 产品功能:防臭下水管

DRAINFORBATHROOMCABINETANDBASIN

- Plasticmaterial:PP/ABS
- Productfuntions:deodorant/Extensible

DW-2023H



G1½活接伸缩排水管

- 塑料材质:PP/PE
- 规格40*800mm/1000mm/1200mm
- 颜色:黑、白、灰

DESCRIPTION:G1½FLEXIBLEDRAINHOSE

- Size:40*80mm/1000mm/1200mm
- Color:Black/White/Grey

DW-2024H



橡塑套排水管

- 塑料材质:PE/TPE
- 规格32*800mm/1000mm/1200mm
- 颜色:黑、白、灰

DESCRIPTION:PLASTIC DRAIN HOSE

- Size:32*800mm/1000mm/1200mm
- Color:Black/White/Grey

DW-2025H

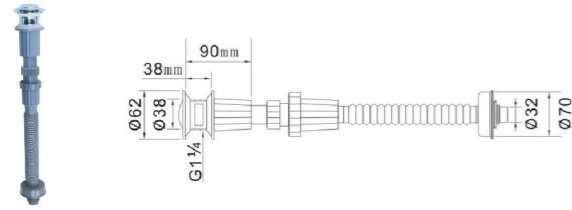

浴室柜、面盆下水器

- 金属材质:铜/不锈钢 塑料材质:PP/ABS
- 开孔尺寸:去水开孔35
- 表面处理:镀铬/拉丝/青古铜/钛金/ORB
- 产品功能:自动溢水、带防臭、可升降、小封水盖弹跳式去水

DRAINFOR BATHROOM CABINET AND BASIN

- Metal material:Copper/Stainless steel
- Hole size:Drainage hole size 35 Surface treatment: CHROME-PLATE/BRUSH/BROZE/TITANUM/ORB
- Product functions:Overflow automatically/deodorant/Adjustable/Small cap /bounce type

DW-2026H

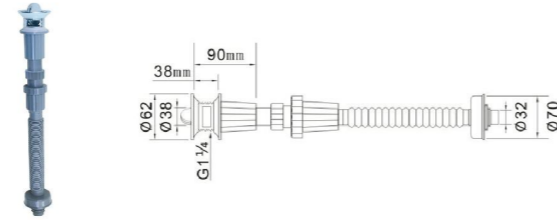

浴室柜、面盆下水器

- 金属材质:铜/不锈钢 塑料材质:PP/ABS
- 开孔尺寸:去水开孔35
- 表面处理:镀铬/拉丝/青古铜/钛金/ORB
- 产品功能:自动溢水、带防臭、可升降、翻板式去水

DRAINFOR BATHROOM CABINET AND BASIN

- Metal material:Copper/Stainless steel
- Hole size:Drainage hole size 35 Surface treatment: CHROME-PLATE/BRUSH/BROZE/TITANUM/ORB
- Product functions:Overflow automatically/deodorant/Adjustable/Small cap